

Recapitulation session

Kees Huizing
Sarmen Keshishzadeh
Alexander Serebrenik
Ulyana Tikhonova
Anton Wijs



TU / **e**

Technische Universiteit
Eindhoven
University of Technology

Exam

- **April 15, 9:00 – 12:00**
- **Location: check OASE**

- **Part I. 20 multiple choice questions (4 options)**
 - 2, if Indicated = Correct
 - 1, if Indicated \subseteq Correct
 - 0, otherwise

- **Part II. Five modeling exercises (15 points each)**
 - Choose four
 - We'll grade the first four

Recapitulation session

- What did you ask us to recapitulate...
 - **UML diagrams**
 - **Architectural styles**
 - **Viewpoints**
 - **Event-B**
- *topics that are most helpful in writing the exam*

Exercises in this session are representative of the exam questions

UML diagram types: Overview

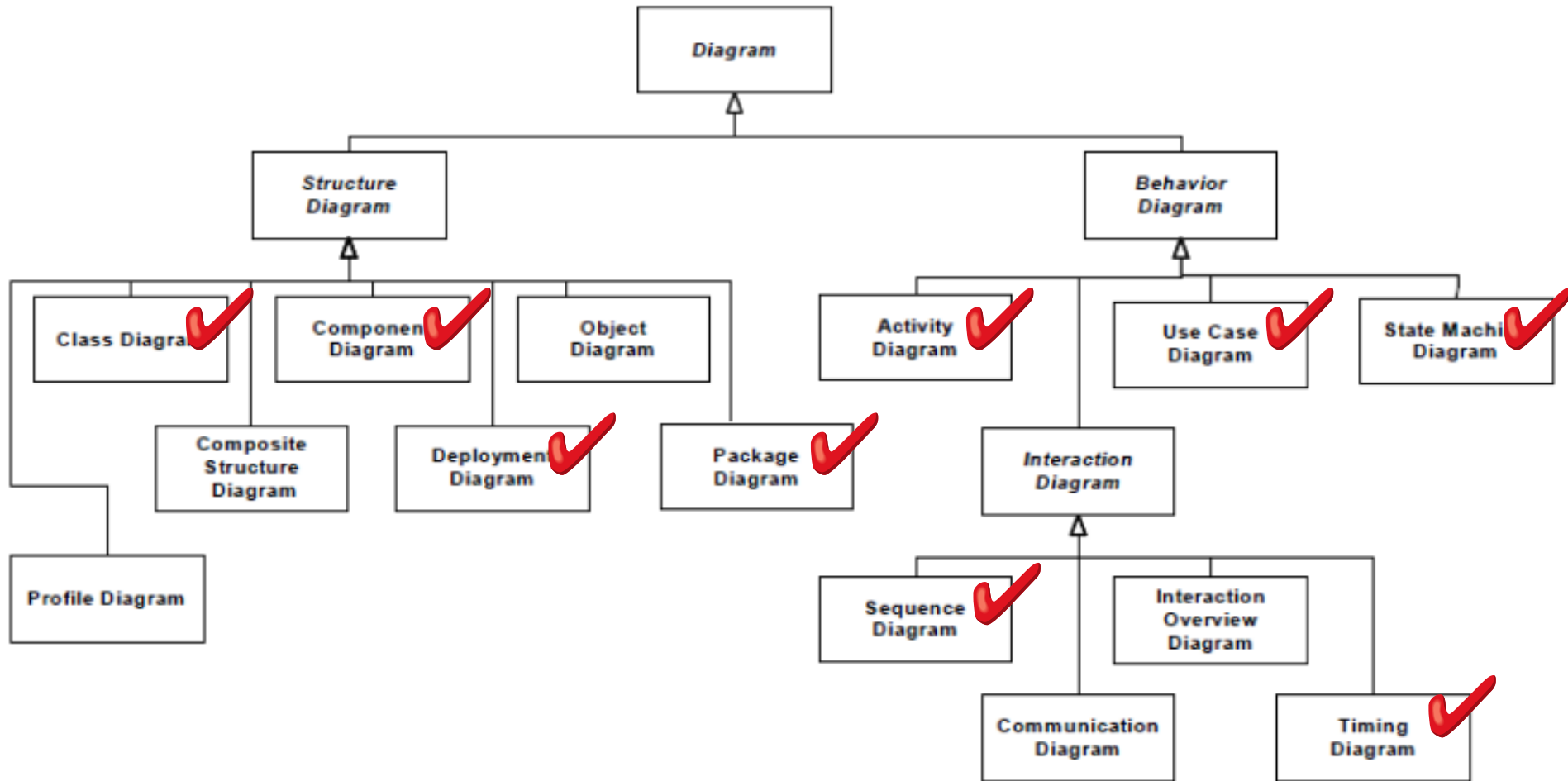

UML class diagram: Overview

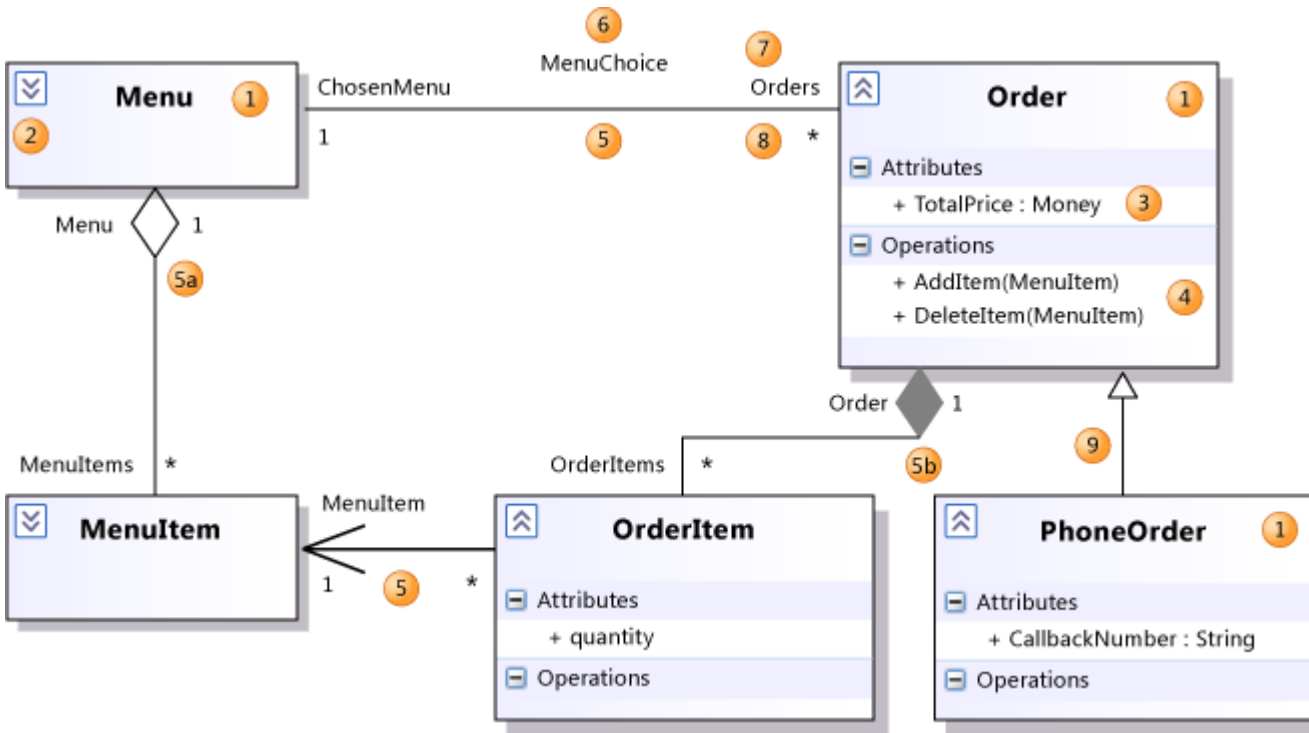

1	Class
3	Attribute
4	Operation
5	Association
5a	Aggregation
5b	Composition
6	Association Name
7	Role Name
8	Multiplicity
9	Generalization

<http://i.msdn.microsoft.com/dynimg/IC315445.png>

Multiple choice question (1)

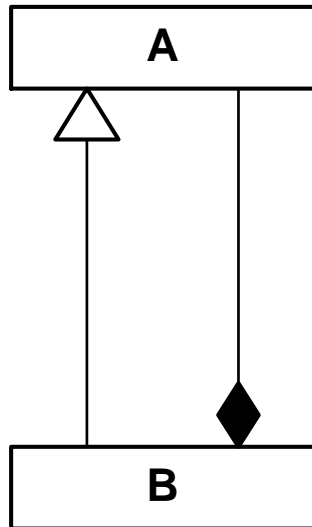

- Class diagram on the left states that
- a) A is a generalization of B
 - b) A is a composition of B
 - c) B is an implementation of A
 - d) The class diagram is syntactically incorrect

Multiple choice question (1)

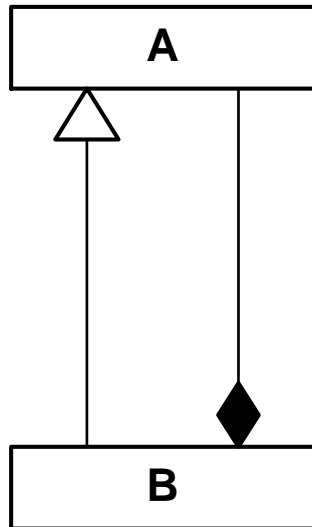

Class diagram on the left states that

- a) **A is a generalization of B**
- b) A is a composition of B
- c) B is an implementation of A
- d) The class diagram is syntactically incorrect

UML sequence diagram: Overview

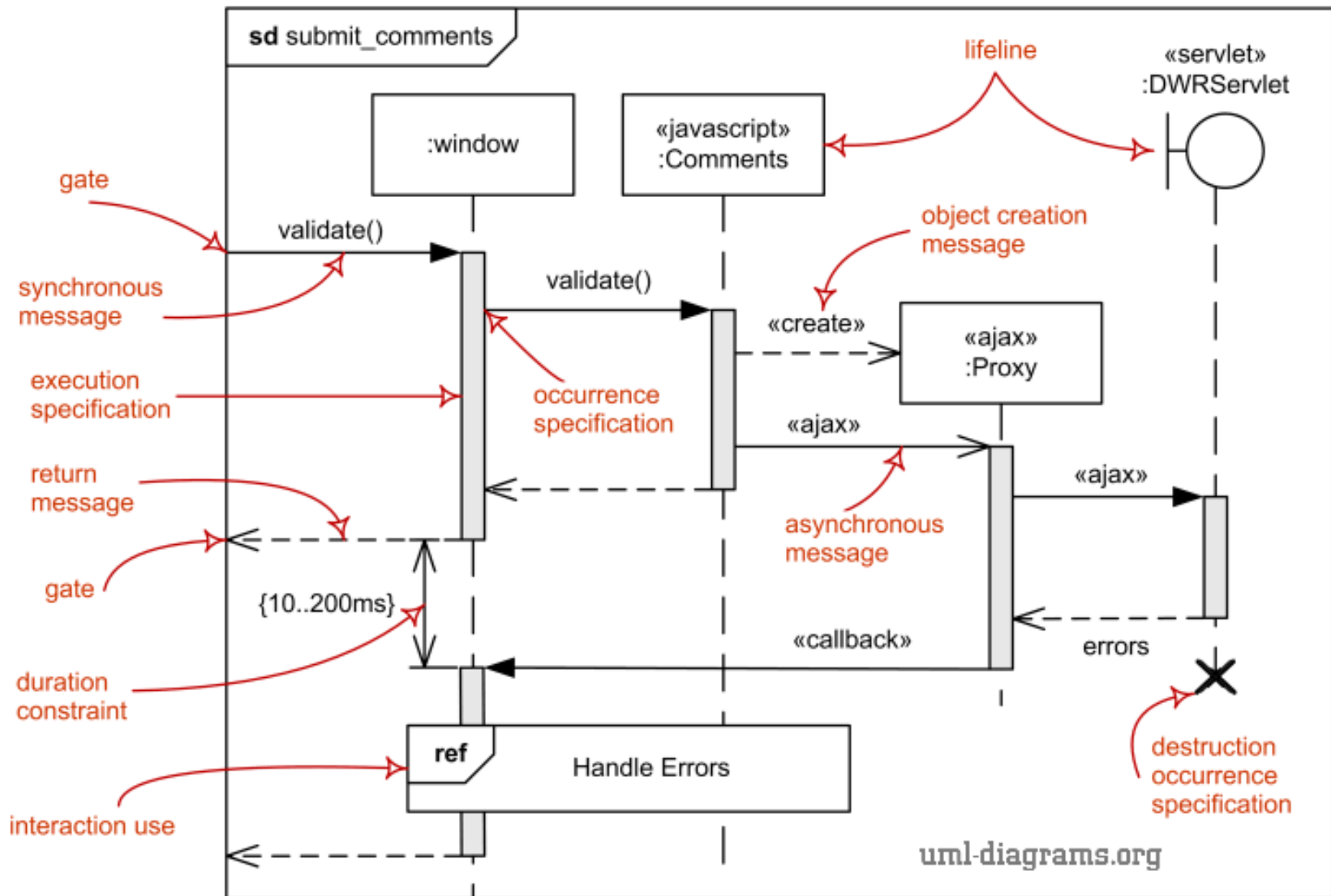

Multiple choice question (2)

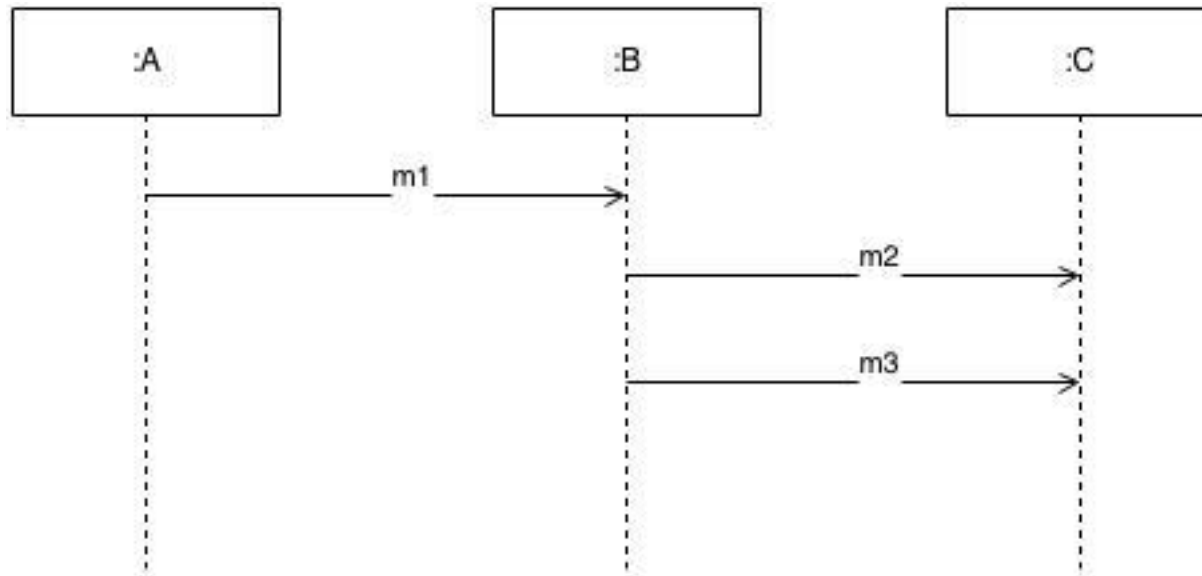

Which of the following statements are not enforced by the sequence diagram?

- a) m1 is received before m2 is send
- b) m2 is received before m3 is send
- c) m1 is send before m2 is send
- d) m2 is send before m3 is send

Multiple choice question (2)

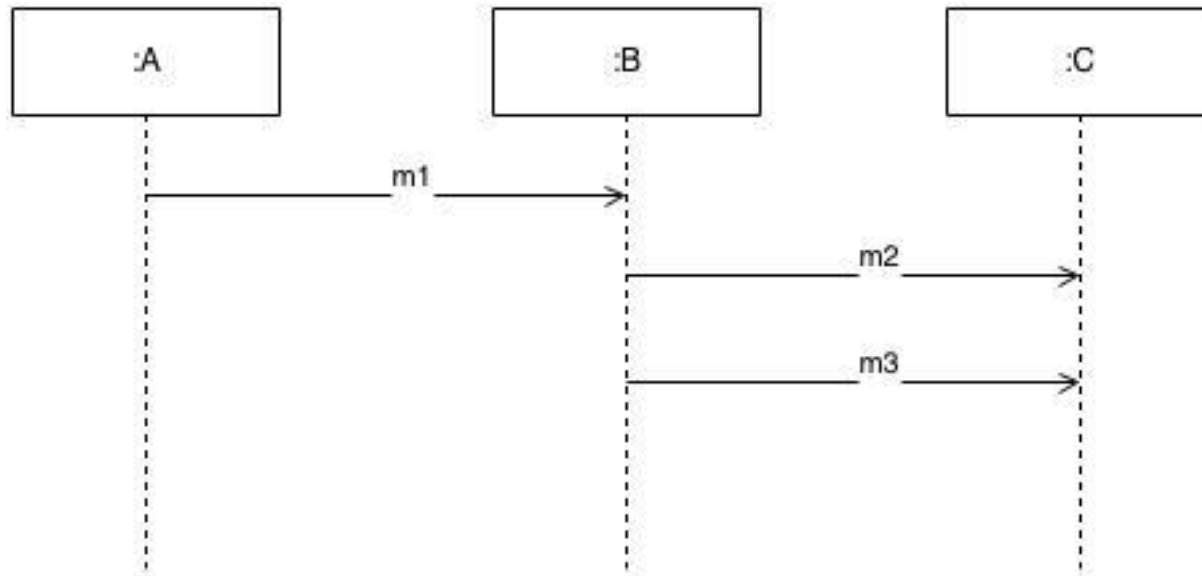

Which of the following statements are not enforced by the sequence diagram?

- a) m1 is received before m2 is send
- b) m2 is received before m3 is send**
- c) m1 is send before m2 is send
- d) m2 is send before m3 is send

Multiple choice question (3)

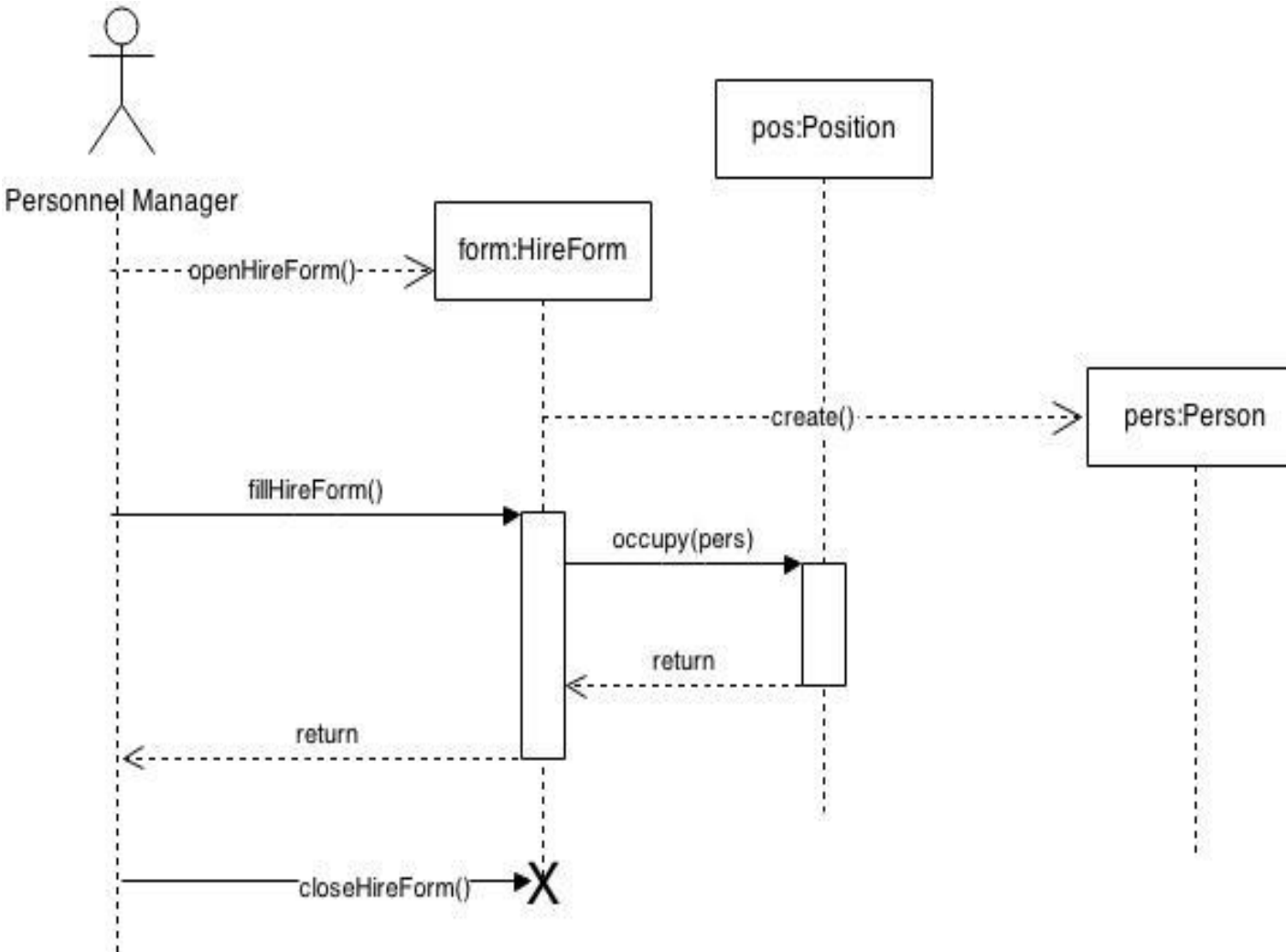

The method **occupy** should be implemented in

- a) HireForm
- b) Person
- c) Position
- d) not enough information in the diagram

Multiple choice question (3)

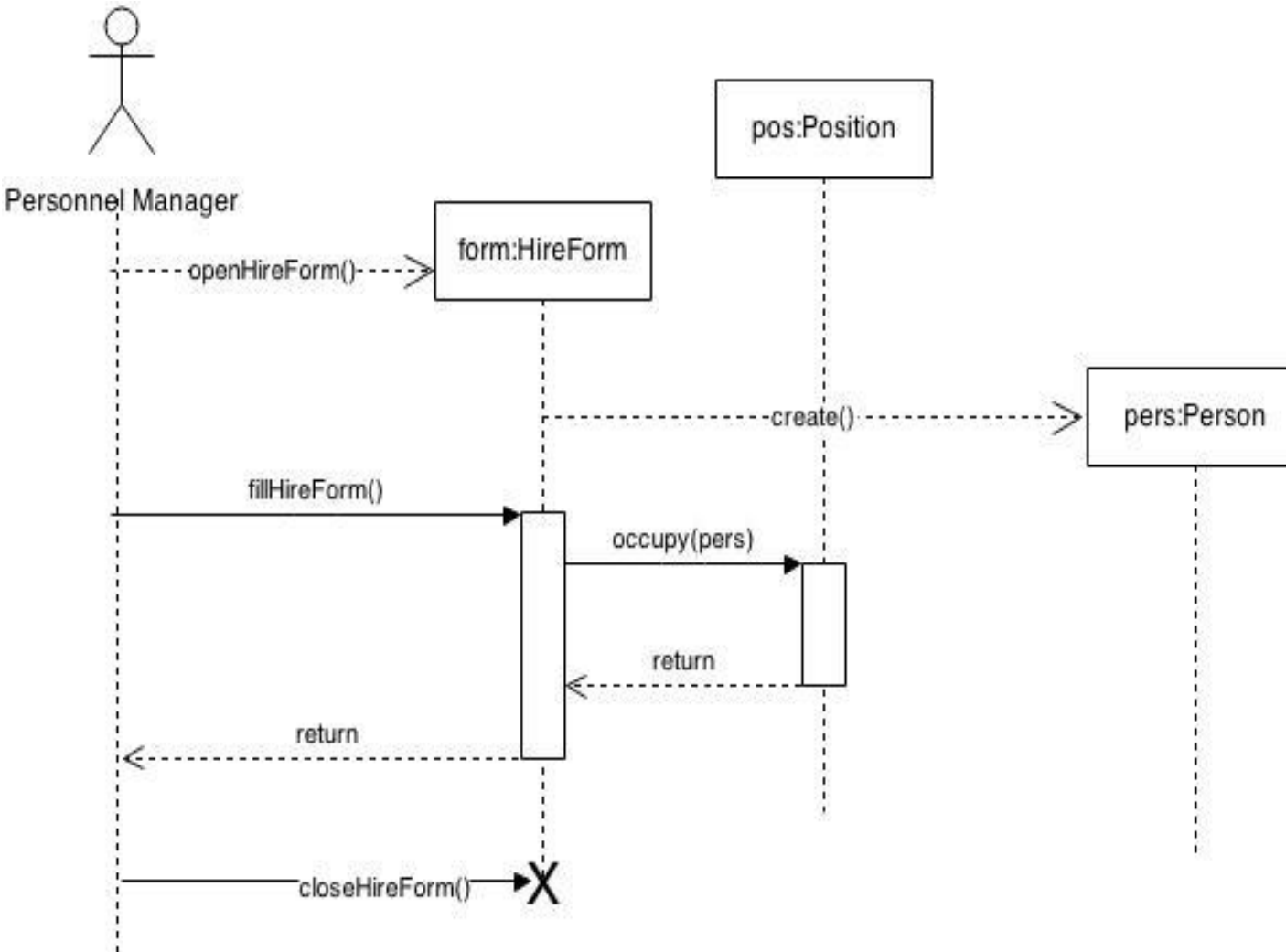

The method **occupy** should be implemented in

- a) HireForm
- b) Person
- c) **Position**
- d) not enough information in the diagram

Important!!!

- **Behavior should be consistent with structure**
 - **Behavior:** sequence diagrams, state machines, activity diagrams, ...
 - **Structure:** class diagrams, package diagrams, ...

Exercise (4.2)

In a file system with a GUI, such as Microsoft's Windows Explorer, the following objects were identified from a use case describing how to copy a file from a floppy disk to a hard disk: File, Icon, TrashCan, Folder, Disk, Pointer.

What are entity objects, boundary objects, and control objects?

Exercise (4.2)

In a file system with a GUI, such as Microsoft's Windows Explorer, the following objects were identified from a use case describing how to copy a file from a floppy disk to a hard disk: File, Icon, TrashCan, Folder, Disk, Pointer.

What are entity objects, boundary objects, and control objects?

Entity objects: File, Folder, Disk

Boundary objects: Icon, Pointer, TrashCan

Control objects: none in this example.

Which object do you need to add to allow one to copy files? What kind of object is it? What would it be responsible for?

Exercise (4.2)

In a file system with a GUI, such as Microsoft's Windows Explorer, the following objects were identified from a use case describing how to copy a file from a floppy disk to a hard disk: File, Icon, TrashCan, Folder, Disk, Pointer.

What are entity objects, boundary objects, and control objects?

Entity objects: File, Folder, Disk

Boundary objects: Icon, Pointer, TrashCan

Control objects: none in this example.

Which object do you need to add to allow one to copy files? What kind of object is it? What would it be responsible for?

CopyFile control object responsible for

Remembering the path of the destination folder

Checking if the file can be copied (access control and disk space).

Remembering the path of the original file

Initiating the file copying

Exercise (4.2)

In a file system with a GUI, such as Microsoft's Windows Explorer, the following objects were identified from a use case describing how to copy a file from a floppy disk to a hard disk: File, Icon, TrashCan, Folder, Disk, Pointer.

Draw the sequence diagram representing interactions resulting from dropping the file into a folder. Ignore the exceptional cases (such as lack of disk space or dropping the file to TrashCan).

Reminder:

Entity objects: File, Folder, Disk

Boundary objects: Icon, Pointer, TrashCan

Control objects: CopyFile

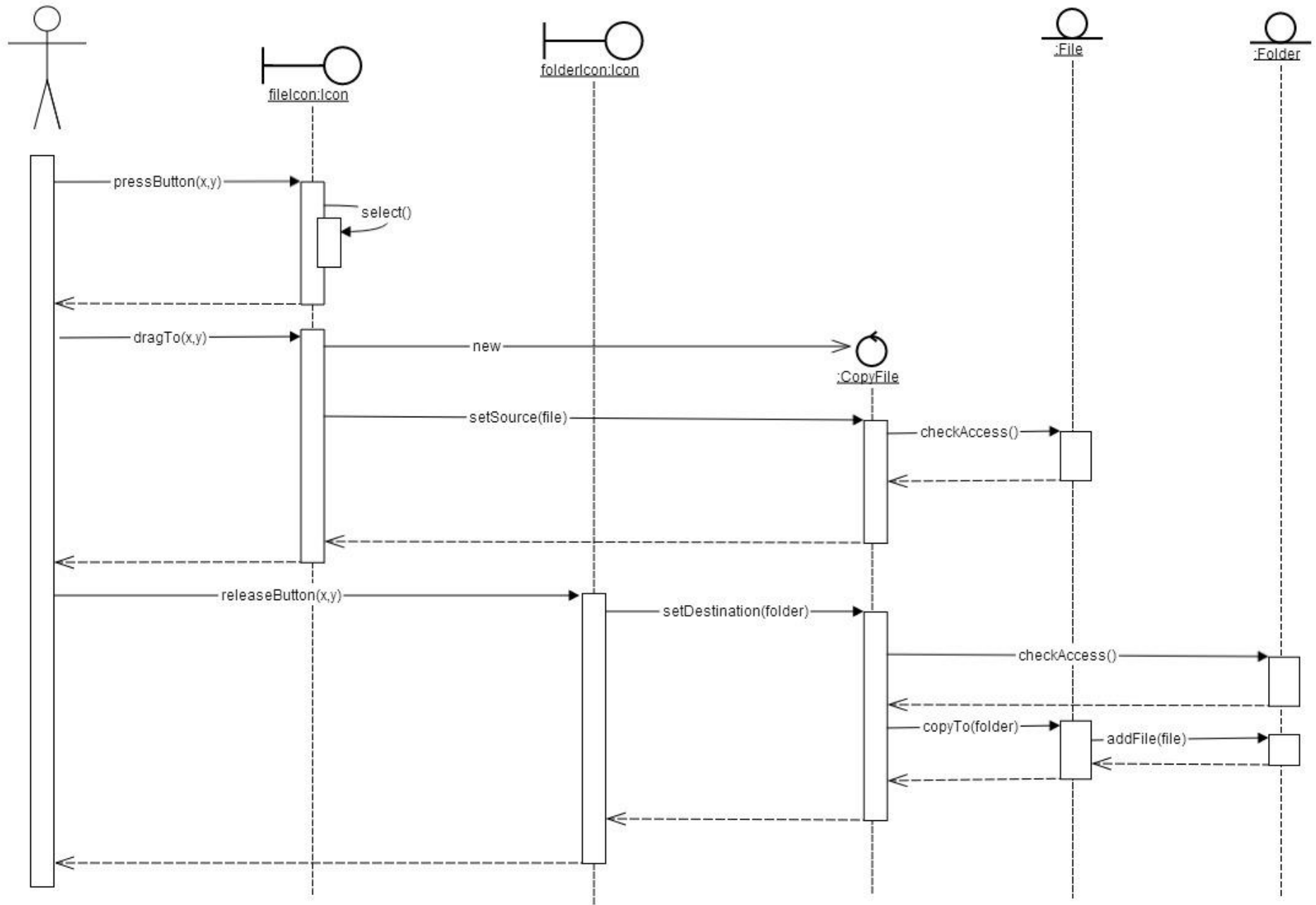

UML use cases: Overview

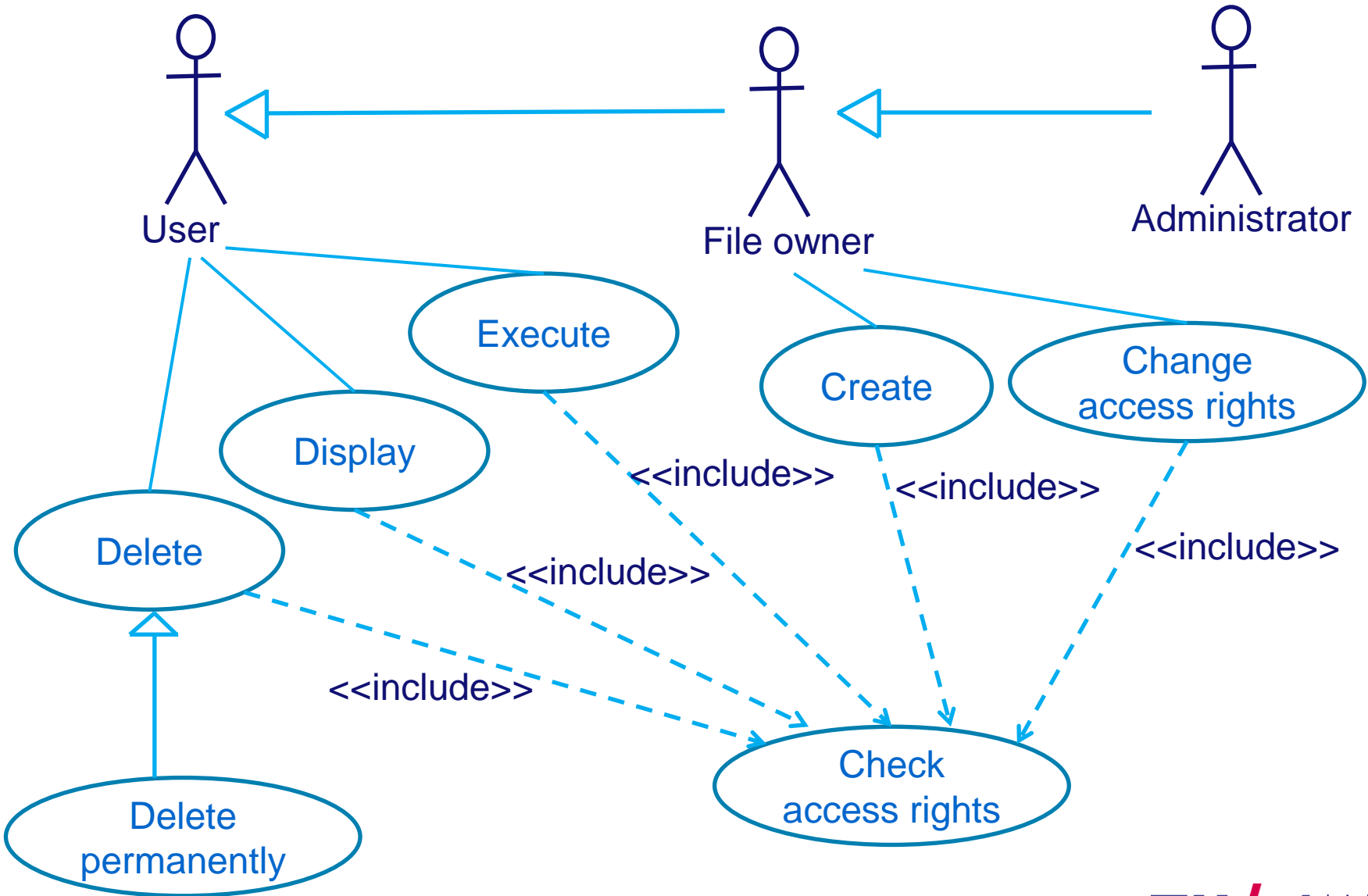

Multiple choice question (4)

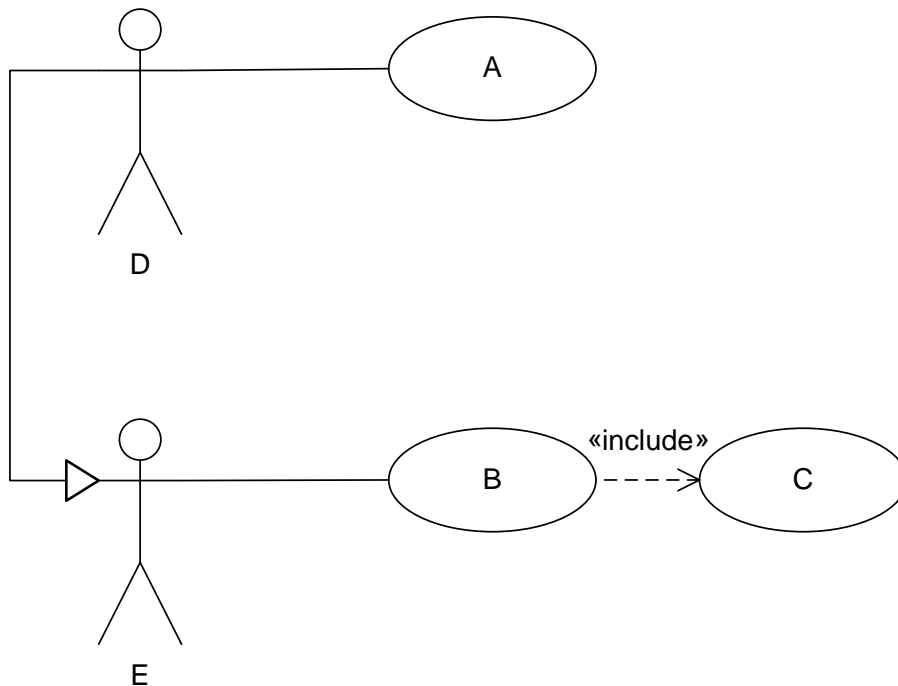

Actor E is associated with activities

- a) A
- b) B
- c) C
- d) none

Multiple choice question (4)

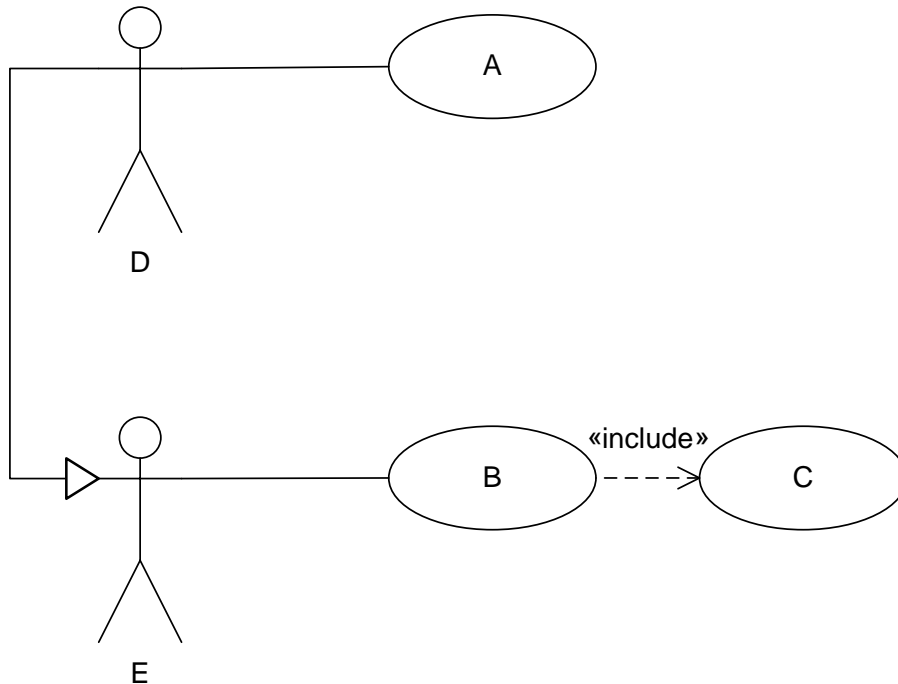

Actor E is associated with activities

- a) A
- b) **B**
- c) **C**
- d) none

Multiple choice question (5)

Let **Withdraw Cash**, **Balance Lookup** and **Debit Account** be use cases corresponding to the diagram above. Which one of the following use case diagrams is correct?

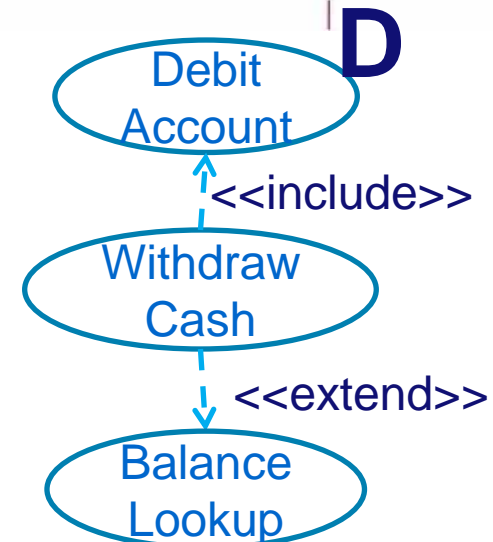
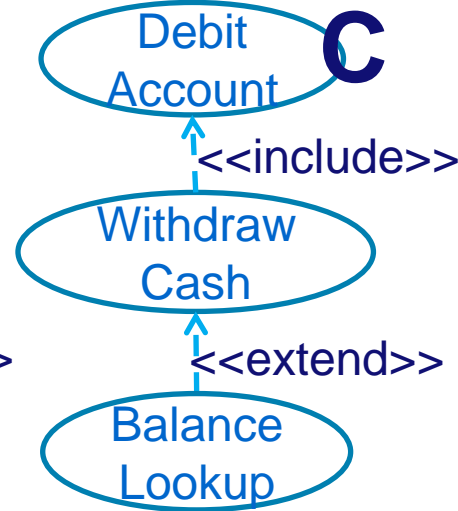
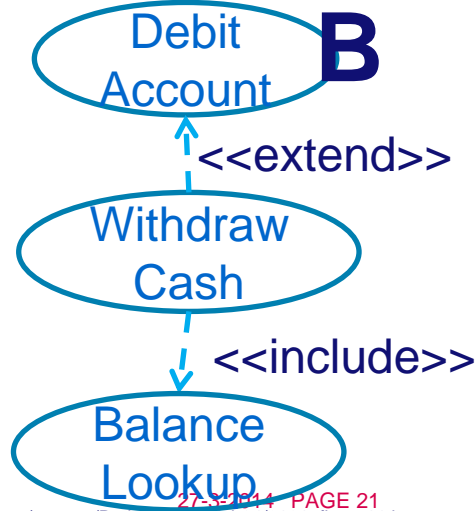
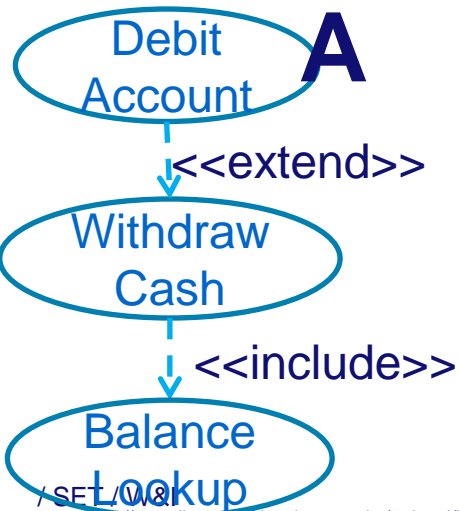
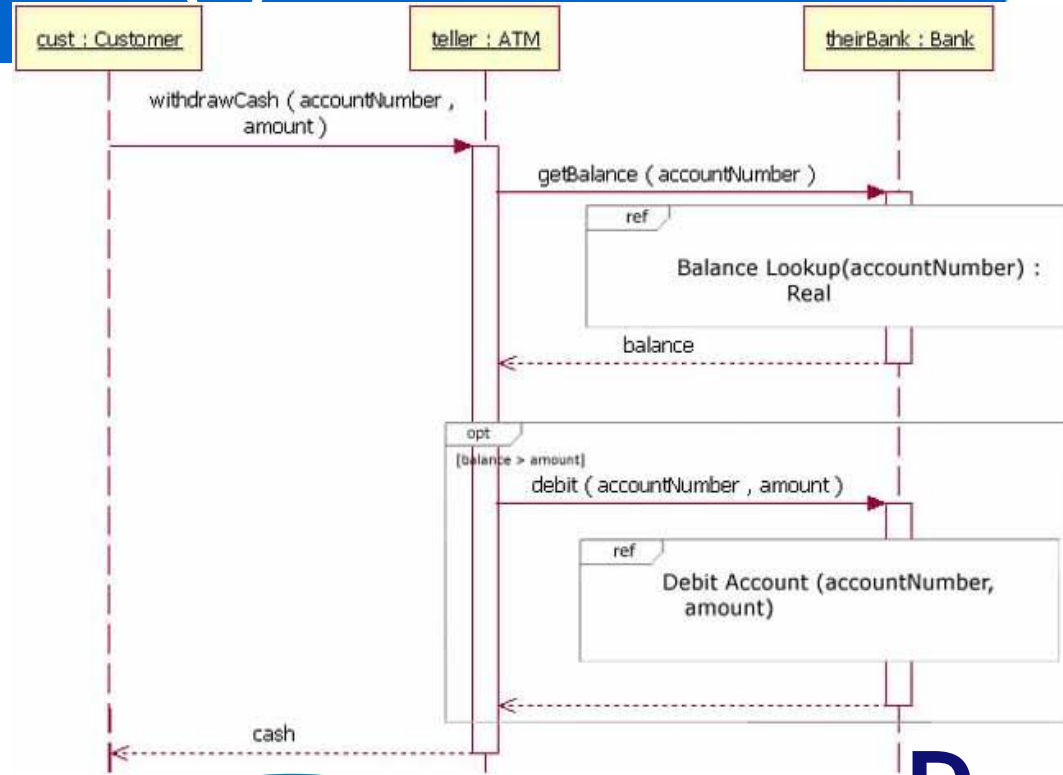

Multiple choice question (5)

Let **Withdraw Cash**, **Balance Lookup** and **Debit Account** be use cases corresponding to the diagram above. Which one of the following use case diagrams is correct?

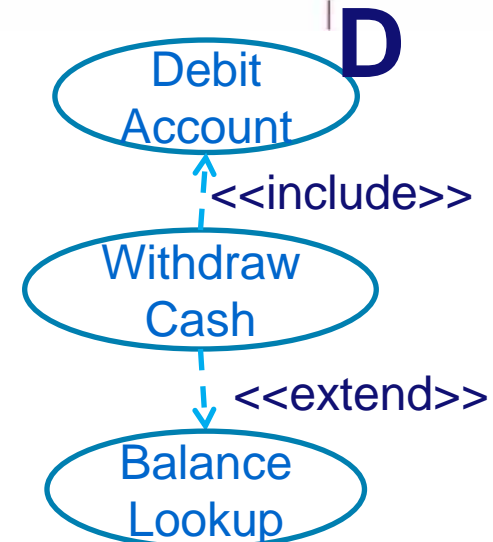
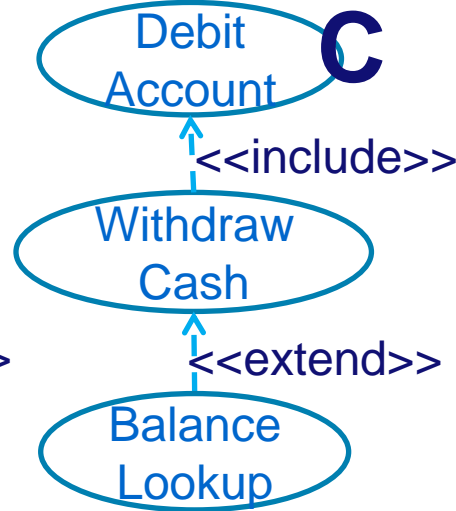
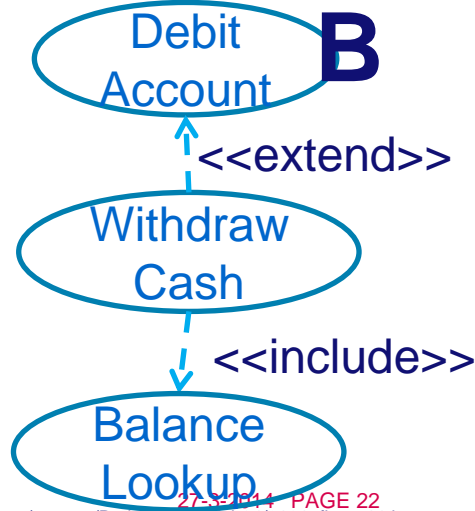
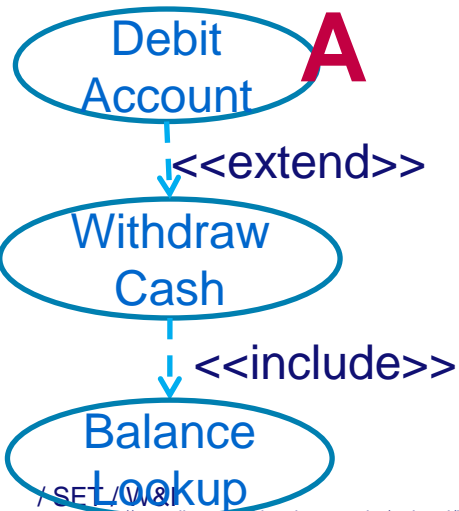
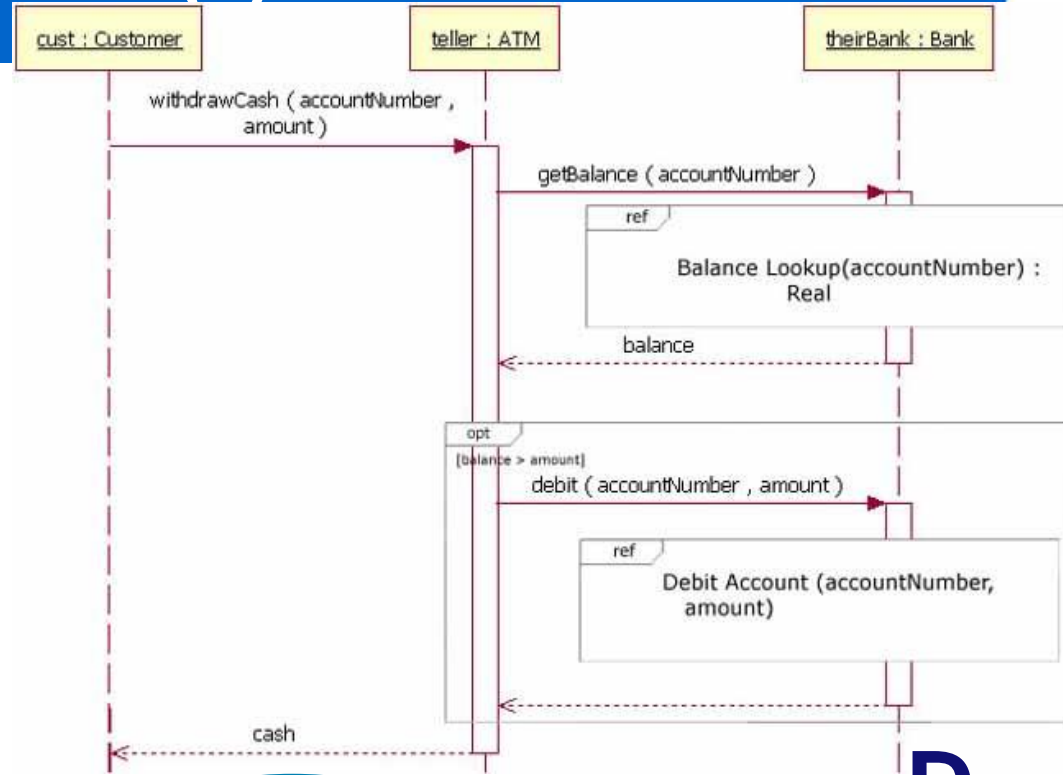

UML state machines: example

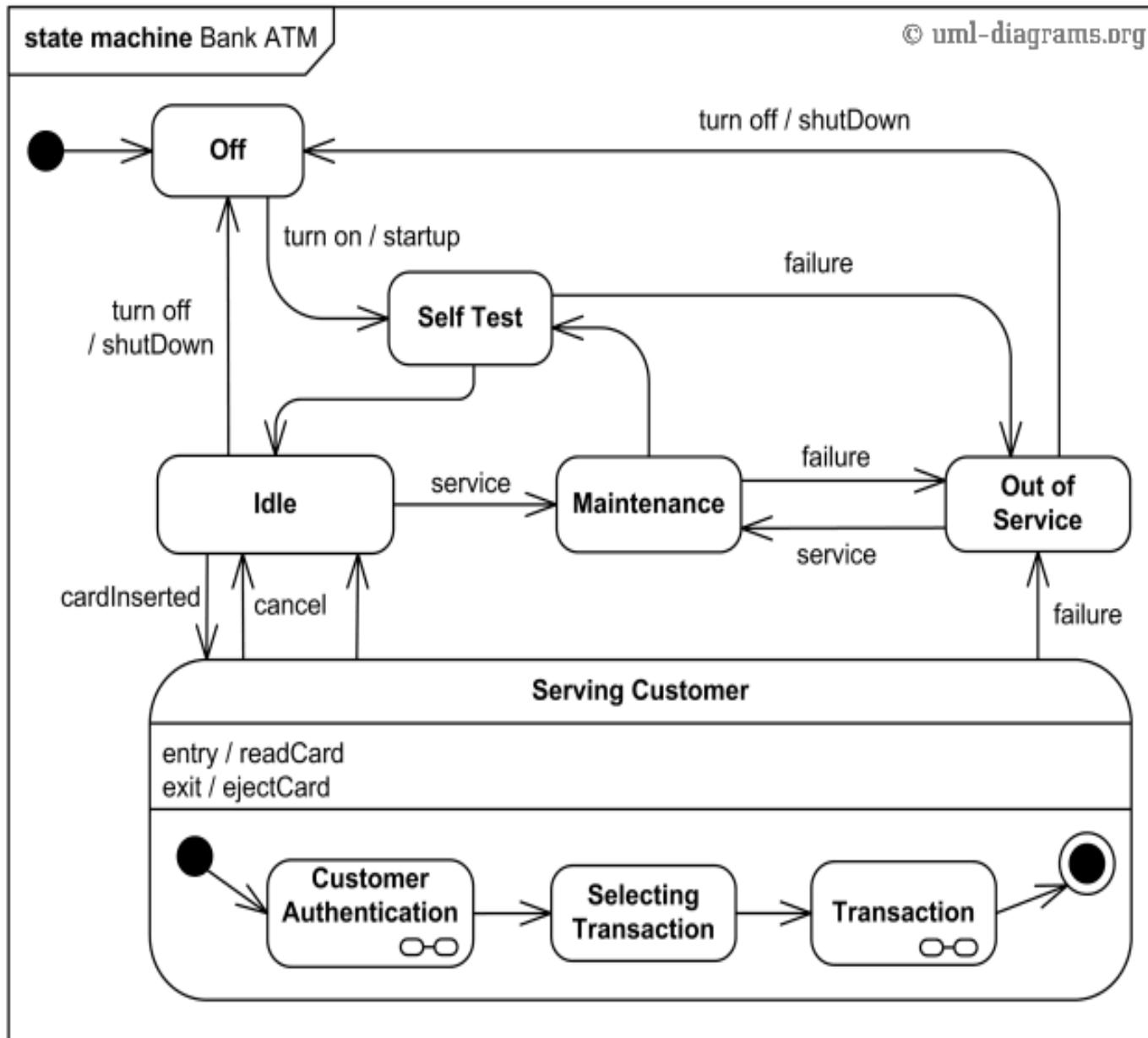

Multiple choice question (6)

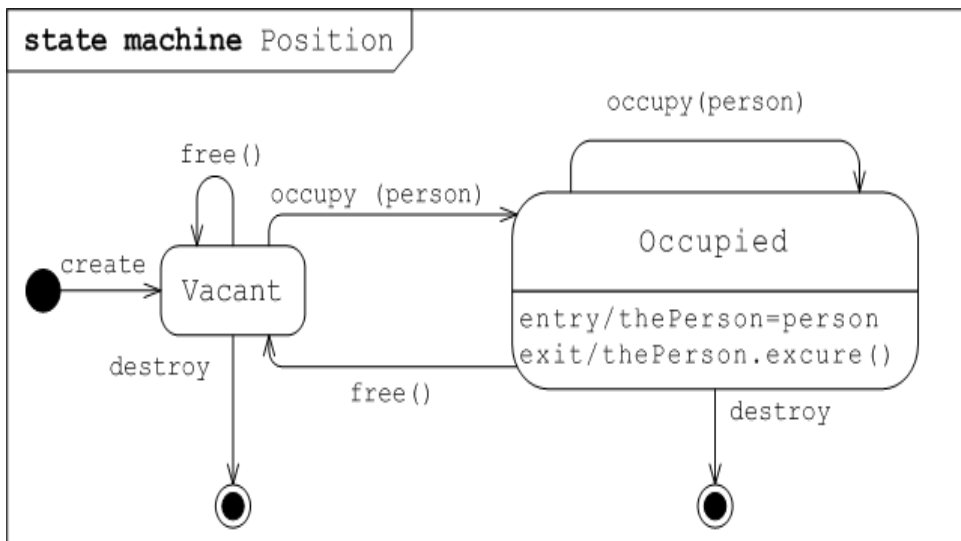
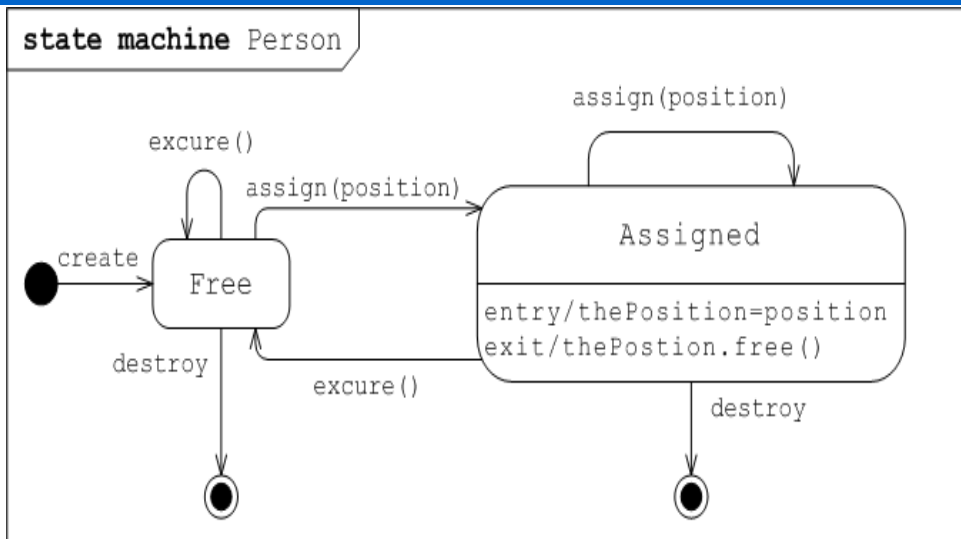

For the Human Resources mang't system on the left which of the following statements **is not necessarily correct**:

- a) class Person has at least 4 methods-2 methods in addition to evt. constructor/destructor
- b) class Position has at most 2 fields
- c) whenever person is "excured" the position is vacant
- d) In the class diagram, cardinality of Person / Position is 0..1 / 0..1

Multiple choice question (6)

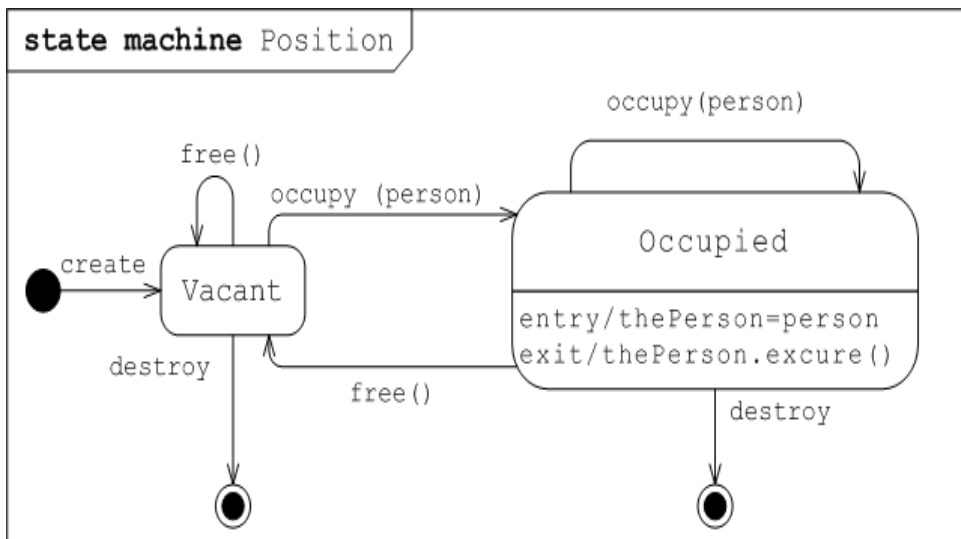
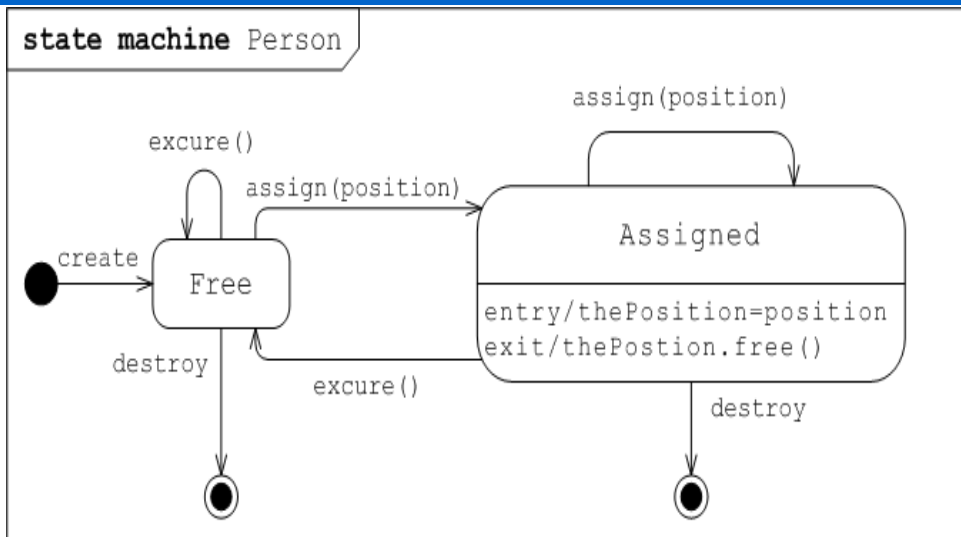

For the Human Resources mang't system on the left which of the following statements **is not necessarily correct**:

- a) class Person has at least 4 methods-2 methods in addition to evt. constructor/destructor
- b) class Position has at most 2 fields**
- c) whenever person is "excured" the position is vacant
- d) In the class diagram, cardinality of Person / Position is 0..1 / 0..1

UML activity diagram: summary

	Graphical representation	Description
Action		action with three inputs
Control flow		start / stop markers
		decision, merge
		fork / join
Signals		incoming (accept), outgoing (send), time-based
Interrupts		interruptible activity region, interrupting edge
Subactivity		activity with input/output parameters, activity invocation
Collection		expansion region

Multiple choice question (7)

- Dr. Smith is grading students' exam papers. How would you model her grading process?

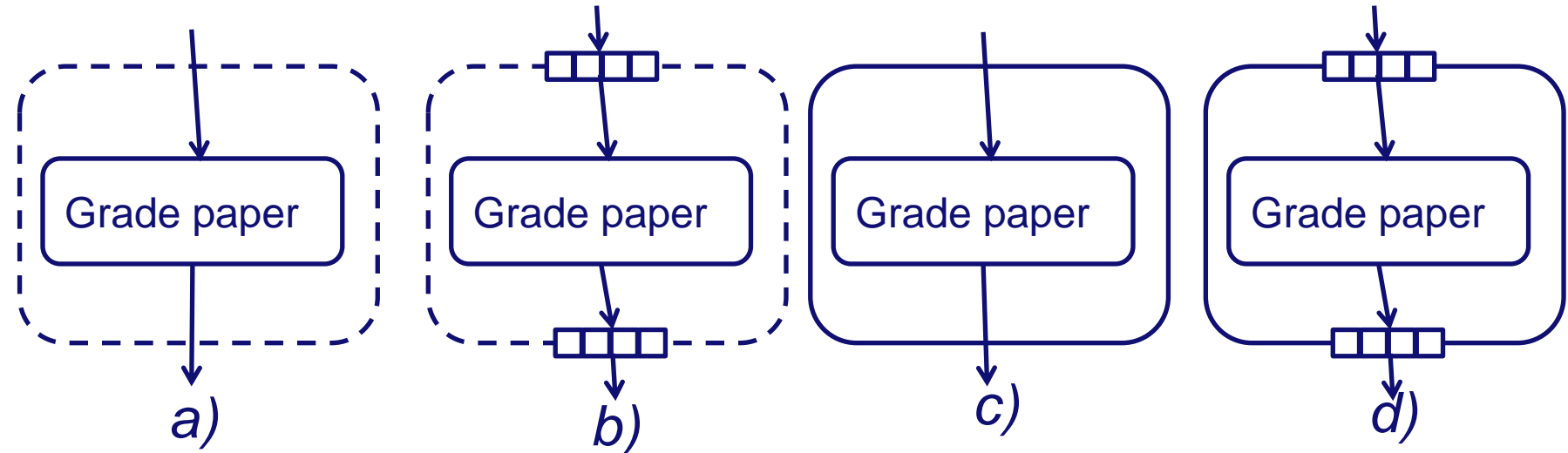

Multiple choice question (7)

- Dr. Smith is grading students' exam papers. How would you model her grading process?

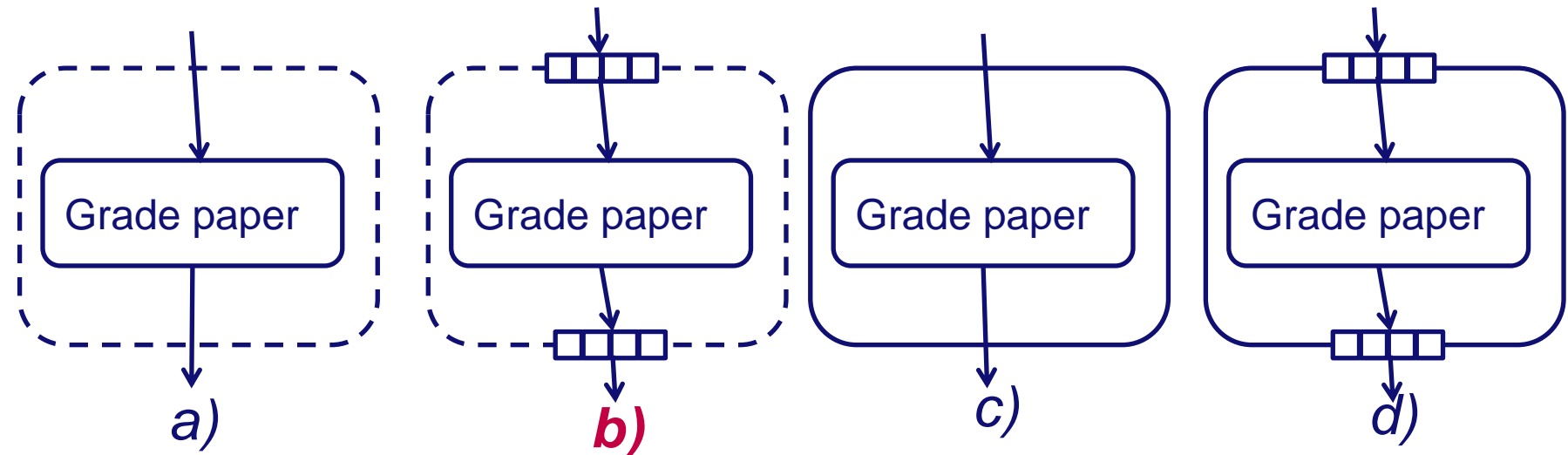

Multiple choice question (8)

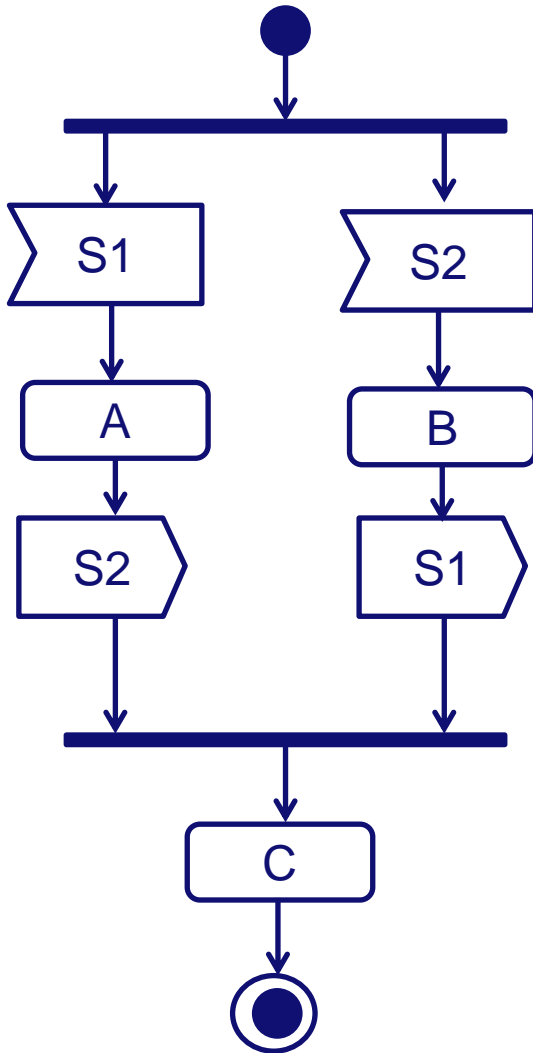

The activity diagram on the left which one of the executions is possible:

- a) A followed by B followed by C
- b) B followed by A followed by C
- c) A followed by C
- d) none of the above

Multiple choice question (8)

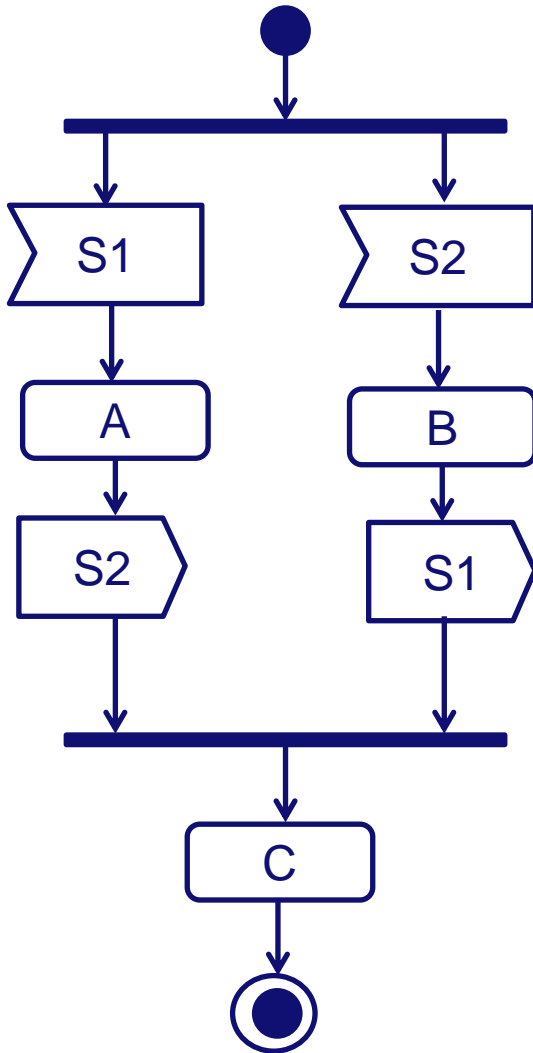

The activity diagram on the left which one of the executions is possible:

- a) A followed by B followed by C
- b) B followed by A followed by C
- c) A followed by C
- d) **none of the above**

Modeling exercise (Exercise 2.4)

The online stock broker first verifies the order against the customer's account, then executes it with the stock exchange.

If the order executes successfully, the system does three things concurrently: mails trade confirmation to the customer, updates the online portfolio to reflect the results of the trade, and settles the trade with the other party by debiting the account and transferring cash or securities.

When all three concurrent threads have been completed, the system merges control into a single thread and closes the order.

If the order execution fails, then the system sends a failure notice to the customer and closes the order.

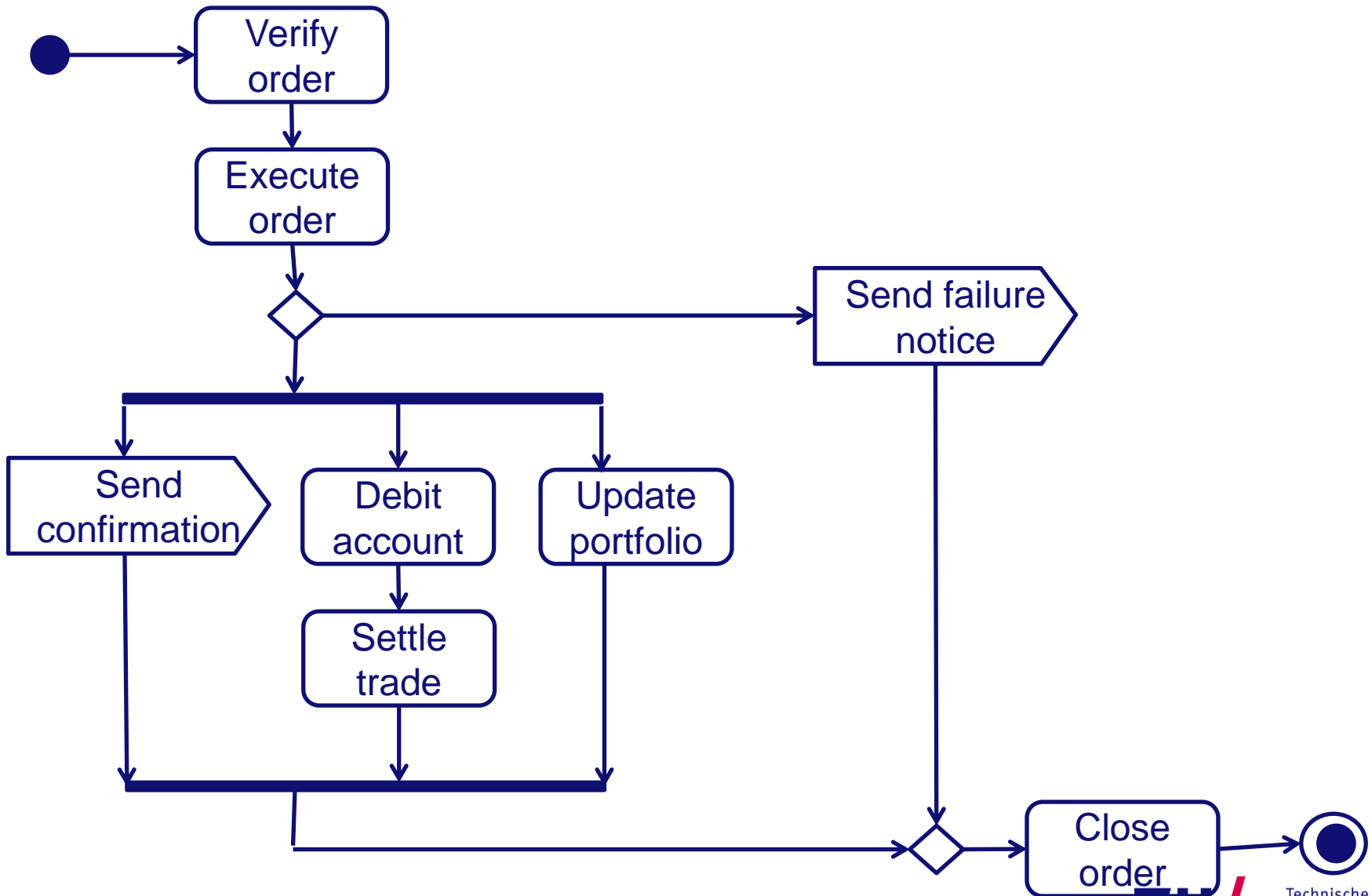

Deployment diagram: an overview

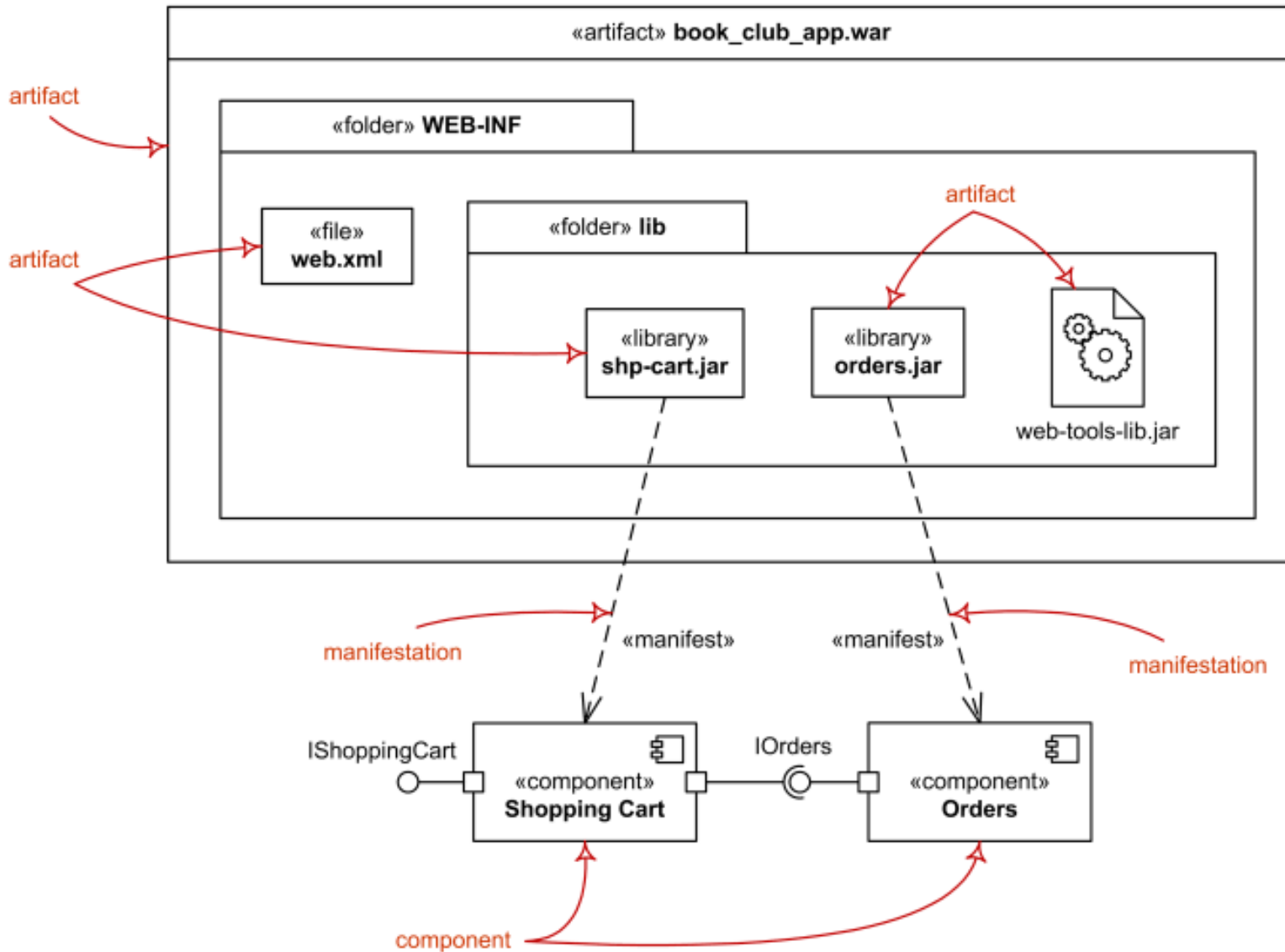

Multiple choice question (9)

- Dependency relation between an archive *eLib.jar* and the class diagram of *eLib* is called
 - a) deployment
 - b) node
 - c) manifestation
 - d) artifact

Multiple choice question (9)

- Dependency relation between an archive *eLib.jar* and the class diagram of *eLib* is called
 - a) deployment
 - b) node
 - c) manifestation**
 - d) artifact

Architectural Styles

- **Traditional, language-influenced** styles
 - Main program and subroutines
 - Object-oriented
- **“Layered”**
 - Layered (“Virtual machines”)
 - Client-server
- **Data-flow** styles
 - Batch sequential
 - Pipe and filter
- **Shared memory**
 - Blackboard
- **Interpreter**
 - Interpreter
 - Mobile code
 - Code-on-demand
 - Remote execution/evaluation
 - Mobile agent
- **Implicit invocation**
 - Event-based
 - Publish-subscribe
- **Peer-to-peer**

Style Summary (1/4)

Style Category & Name	Summary	Use It When	Avoid It When
Language-influenced styles			
Main Program and Subroutines	Main program controls program execution, calling multiple subroutines.	Application is small and simple.	Complex data structures needed. Future modifications likely.
Object-oriented	Objects encapsulate state and accessing functions	Close mapping between external entities and internal objects is sensible. Many complex and interrelated data structures.	Application is distributed in a heterogeneous network. Strong independence between components necessary. High performance required.
Layered			
Virtual Machines	Virtual machine, or a layer, offers services to layers above it	Many applications can be based upon a single, common layer of services. Interface service specification resilient when implementation of a layer must change.	Many levels are required (causes inefficiency). Data structures must be accessed from multiple layers.
Client-server	Clients request service from a server	Centralization of computation and data at a single location (the server) promotes manageability and scalability; end-user processing limited to data entry and presentation.	Centrality presents a single-point-of-failure risk; Network bandwidth limited; Client machine capabilities rival or exceed the server's.

Style Summary, continued (2/4)

Data-flow styles

Batch sequential	Separate programs executed sequentially, with batched input	Problem easily formulated as a set of sequential, severable steps.	Interactivity or concurrency between components necessary or desirable. Random-access to data required.
Pipe-and-filter	Separate programs, a.k.a. filters, executed, potentially concurrently. Pipes route data streams between filters	[As with batch-sequential] Filters are useful in more than one application. Data structures easily serializable.	Interaction between components required. Exchange of complex data structures between components required.

Shared memory

Blackboard	Independent programs, access and communicate exclusively through a global repository known as blackboard	All calculation centers on a common, changing data structure; Order of processing dynamically determined and data-driven.	Programs deal with independent parts of the common data. Interface to common data susceptible to change. When interactions between the independent programs require complex regulation.
------------	--	--	---

Style Summary, continued (3/4)

Interpreter

Interpreter

Interpreter parses and executes the input stream, updating the state maintained by the interpreter

Highly dynamic behavior required. High degree of end-user customizability.

High performance required.

Mobile Code

Code is mobile, that is, it is executed in a remote host

When it is more efficient to move processing to a data set than the data set to processing. When it is desirable to dynamically customize a local processing node through inclusion of external code

Security of mobile code cannot be assured, or sandboxed. When tight control of versions of deployed software is required.

Style Summary, continued (4/4)

Implicit Invocation

Publish-
subscribe

Publishers broadcast
messages to subscribers

Components are very loosely
coupled. Subscription data is
small and efficiently transported.

When middleware to support high-
volume data is unavailable.

Event-based

Independent components
asynchronously emit and
receive events
communicated over event
buses

Components are concurrent and
independent.
Components heterogeneous and
network-distributed.

Guarantees on real-time
processing of events is required.

Peer-to-peer

Peers hold state and
behavior and can act as
both clients and servers

Peers are distributed in a
network, can be heterogeneous,
and mutually independent.
Robust in face of independent
failures.
Highly scalable.

Trustworthiness of independent
peers cannot be assured or
managed.
Resource discovery inefficient
without designated nodes.

Multiple choice question (10)

http://kevinnam.com/?page_id=175

Read the following text and replace **XXX** with one of the answers:

Virtual communities, like any community of people, often have trouble regulating their participants. This project's approach includes the design and implementation of an agent-based system written in Java that helps facilitate and regulate online social spaces appropriately and also helps maintain a pleasurable environment for users. The system comprises of a number of agents that work collaboratively through a **XXX** architecture. Each agent looks for a specific problem, and new agents can be built and added to the system as required. This system as a whole is not designed to completely eliminate the need for human regulator, but rather to help reduce human intervention in regulating online communities.

- a) publish-subscribe
- b) client-server
- c) pipe-and-filter
- d) blackboard

Multiple choice question (10)

http://kevinnam.com/?page_id=175

Read the following text and replace **XXX** with one of the answers:

Virtual communities, like any community of people, often have trouble regulating their participants. This project's approach includes the design and implementation of an agent-based system written in Java that helps facilitate and regulate online social spaces appropriately and also helps maintain a pleasurable environment for users. The system comprises of a number of agents that work collaboratively through a **XXX** architecture. Each agent looks for a specific problem, and new agents can be built and added to the system as required. This system as a whole is not designed to completely eliminate the need for human regulator, but rather to help reduce human intervention in regulating online communities.

- a) publish-subscribe
- b) client-server
- c) pipe-and-filter
- d) **blackboard**

Multiple-choice question (11)

<http://msdn.microsoft.com/en-us/library/ff647328.aspx>

Consider a financial application that integrates trading tools, portfolio management applications, modeling and risk analysis tools, trend indicators, and tickers. Market activity causes interaction between these systems. For example, a trading system communicates the completion of a sell transaction by sending a message to all other trading applications. <...> Managing the addition or removal of trading applications should not interfere with processing trades.

Which architectural style would you apply to implement this application?

- a) code-on-demand
- b) event-based
- c) batch-sequential
- d) peer-to-peer

Multiple-choice question (11)

<http://msdn.microsoft.com/en-us/library/ff647328.aspx>

Consider a financial application that integrates trading tools, portfolio management applications, modeling and risk analysis tools, trend indicators, and tickers. Market activity causes interaction between these systems. For example, a trading system communicates the completion of a sell transaction by sending a message to all other trading applications. <...> Managing the addition or removal of trading applications should not interfere with processing trades.

Which architectural style would you apply to implement this application?

- a) code-on-demand
- b) **event-based**
- c) batch-sequential
- d) peer-to-peer

Exercise (6.3)

A mobile robot has to acquire the input provided by its sensors, control the motion of its wheels and plan its future path. Beware:

- Obstacles may block the robot's path.
- The sensor input may be imperfect.
- The robot may run out of power.
- Mechanical limitations may restrict the accuracy with which the robot moves.
- The robot may manipulate hazardous materials.
- Unpredictable events may leave little time for responding.

Design an architecture for the mobile robot applying:

- (Strict) layered style.
- Blackboard style.

Strict layered style

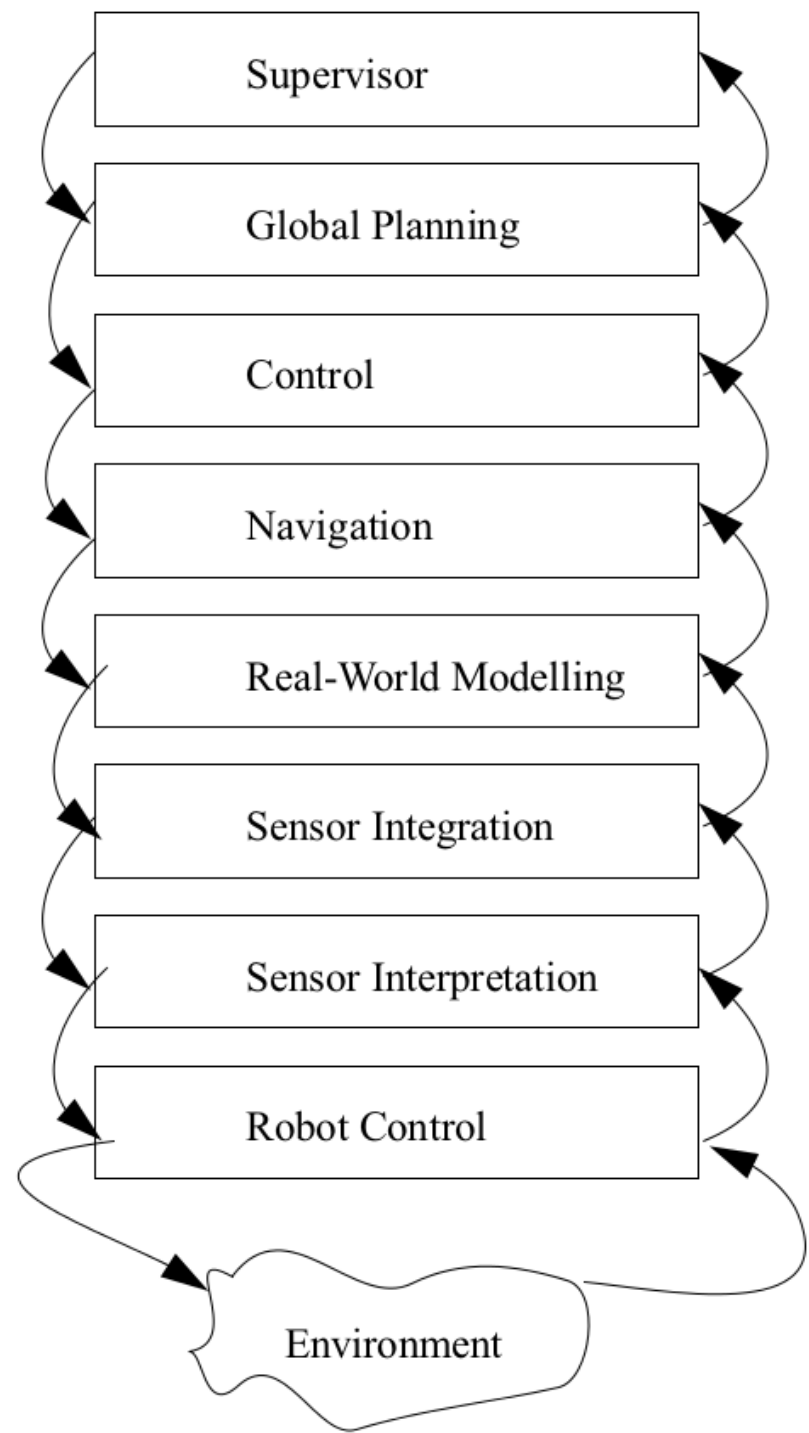

Strict layered style

- In reality the information exchange is less straightforward
 - Levels may be skipped because of the timing constraints.
- Advantage:
 - abstraction layers stress roles and organization of components
- Disadvantage:
 - unrealistic communication patterns

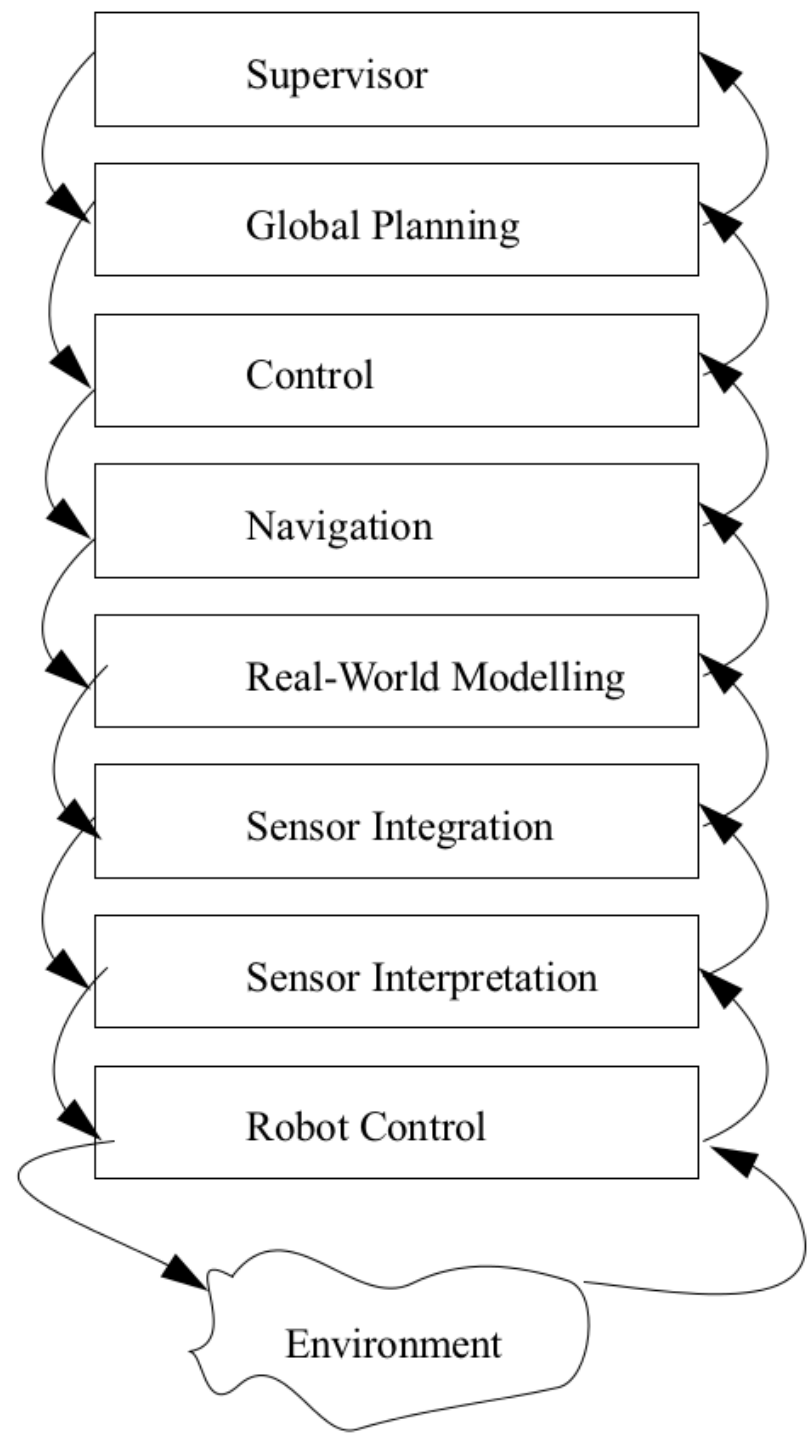

Blackboard style

- **Captain:** overall supervisor.
- **Map navigator:** high level path planner.
- **Lookout:** monitors the environment for landmarks.
- **Pilot:** low level path planner and motor controller.
- **Perception subsystem:** modules that accept the raw input from multiple sensors and integrate it into a coherent interpretation.

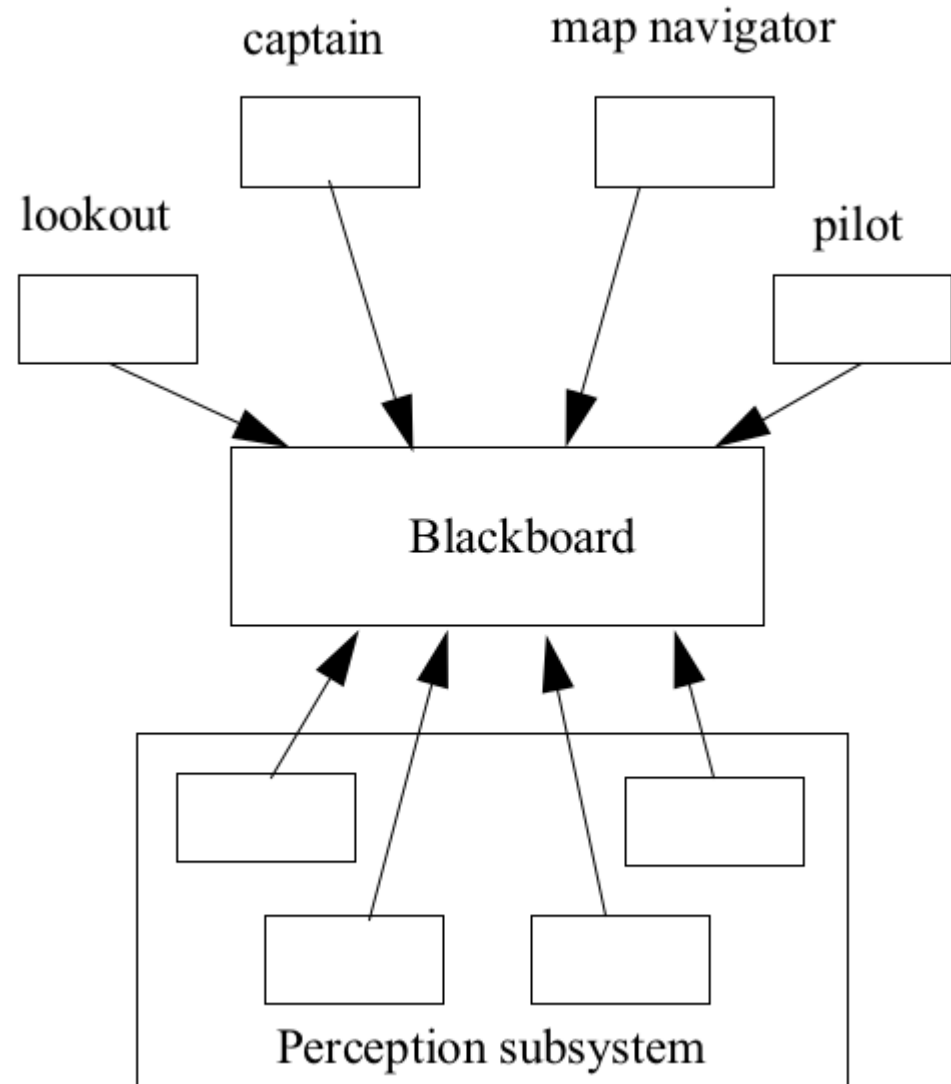

Blackboard style

- Advantages
 - Support for collaboration, dealing with uncertainty, flexible
- Disadvantages (challenges)
 - Performance, fault tolerance, safety

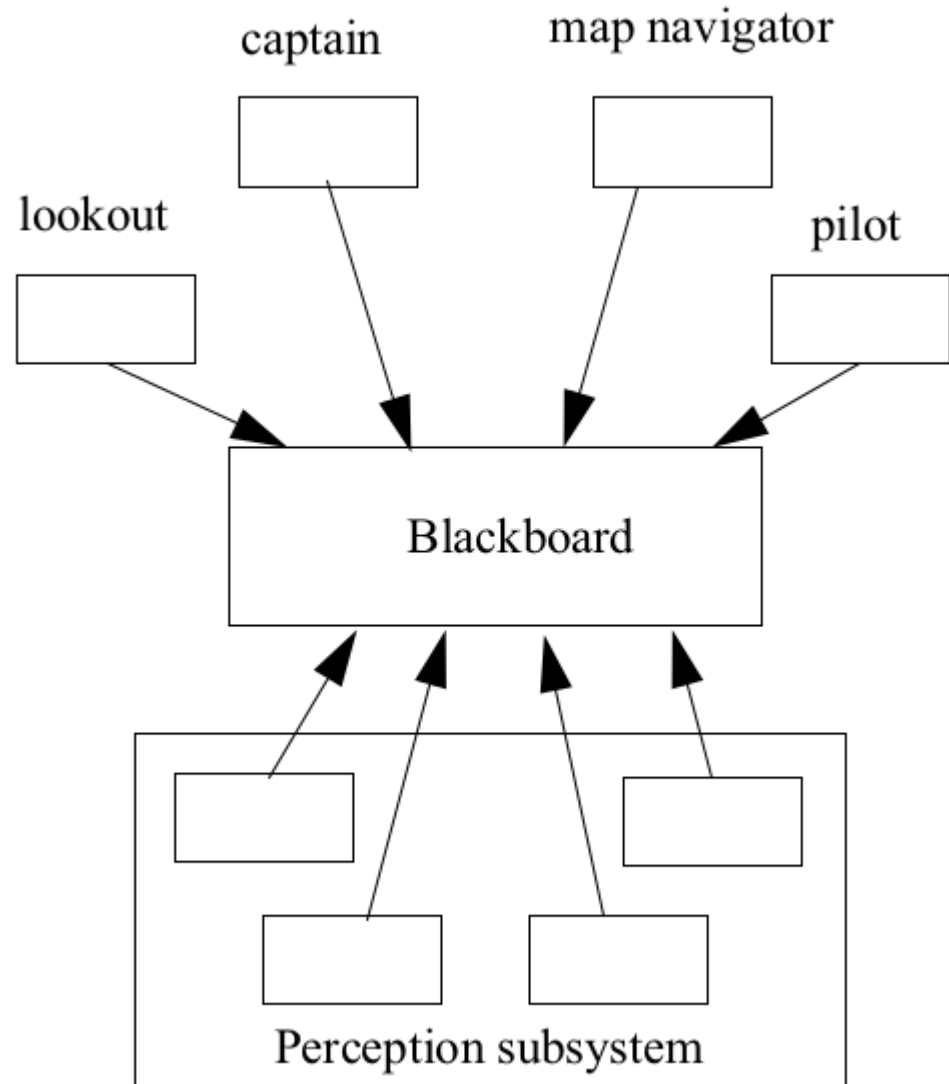

Viewpoints and views

- **Viewpoint** a way of looking at a system from the position of a certain *stakeholder* with a particular *concern*
 - defines creation, depiction and analysis of a view
 - language, used models, notation, methods, analysis techniques
- **View**: whatever you see in a system from a particular viewpoint
 - collection of system models
 - conforming to the viewpoint

Multiple choice question (12)

Which of the following statements from the following list are not correct?

- a) using viewpoints the architects can separate out different kinds of information
- b) the need to maintain multiple views describing a software system as well as consistency between those views hinders maintenance of the architecture documentation
- c) pipe-and-filter architectural style can be considered as a structural viewpoint
- d) according to IEEE Std. 42010-2011 viewpoint can exist without stakeholders.

Multiple choice question (12)

Which of the following statements from the following list are not correct?

- a) using viewpoints the architects can separate out different kinds of information
- b) the need to maintain multiple views describing a software system as well as consistency between those views hinders maintenance of the architecture documentation
- c) pipe-and-filter architectural style can be considered as a structural viewpoint
- d) **according to IEEE Std. 42010-2011 viewpoint can exist without stakeholders.**

Question

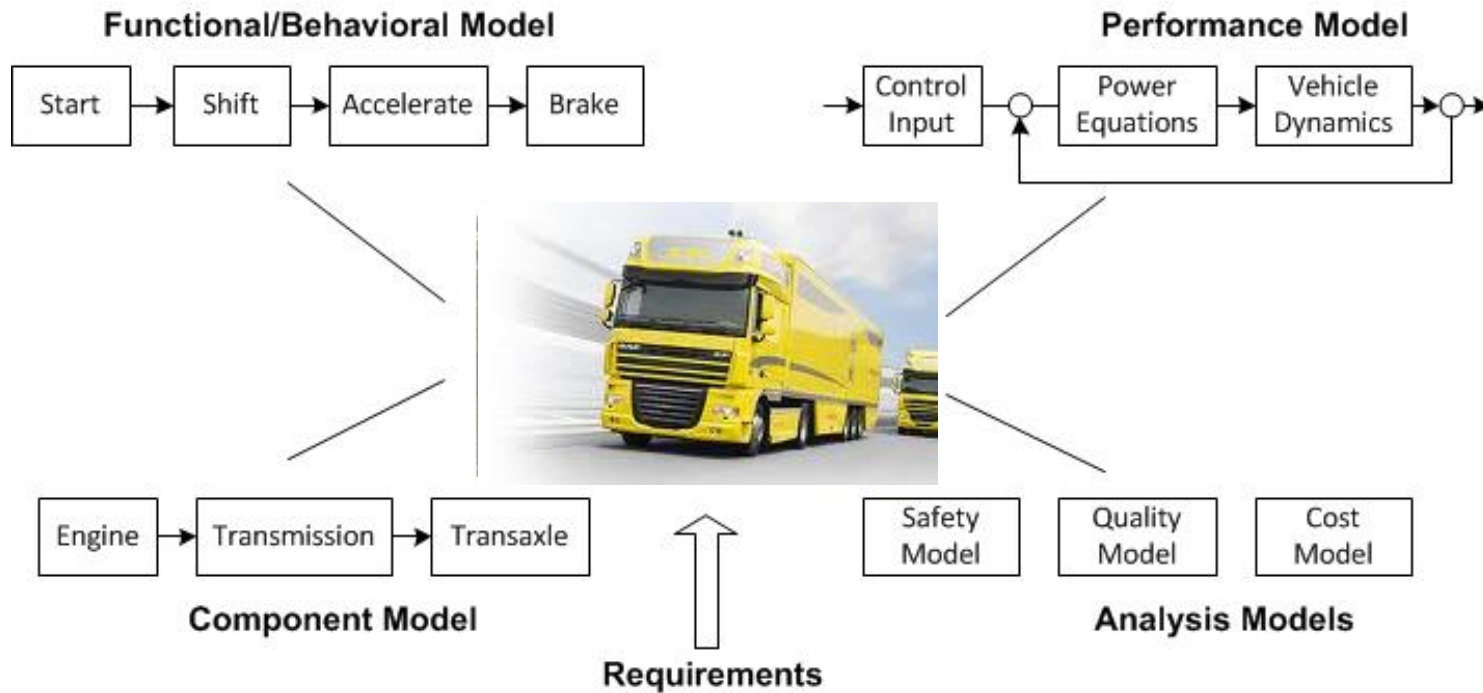

Another take on *viewpoints* (here called *model(s)*)

Can you map those models to Kruchten's 4+1?

Question

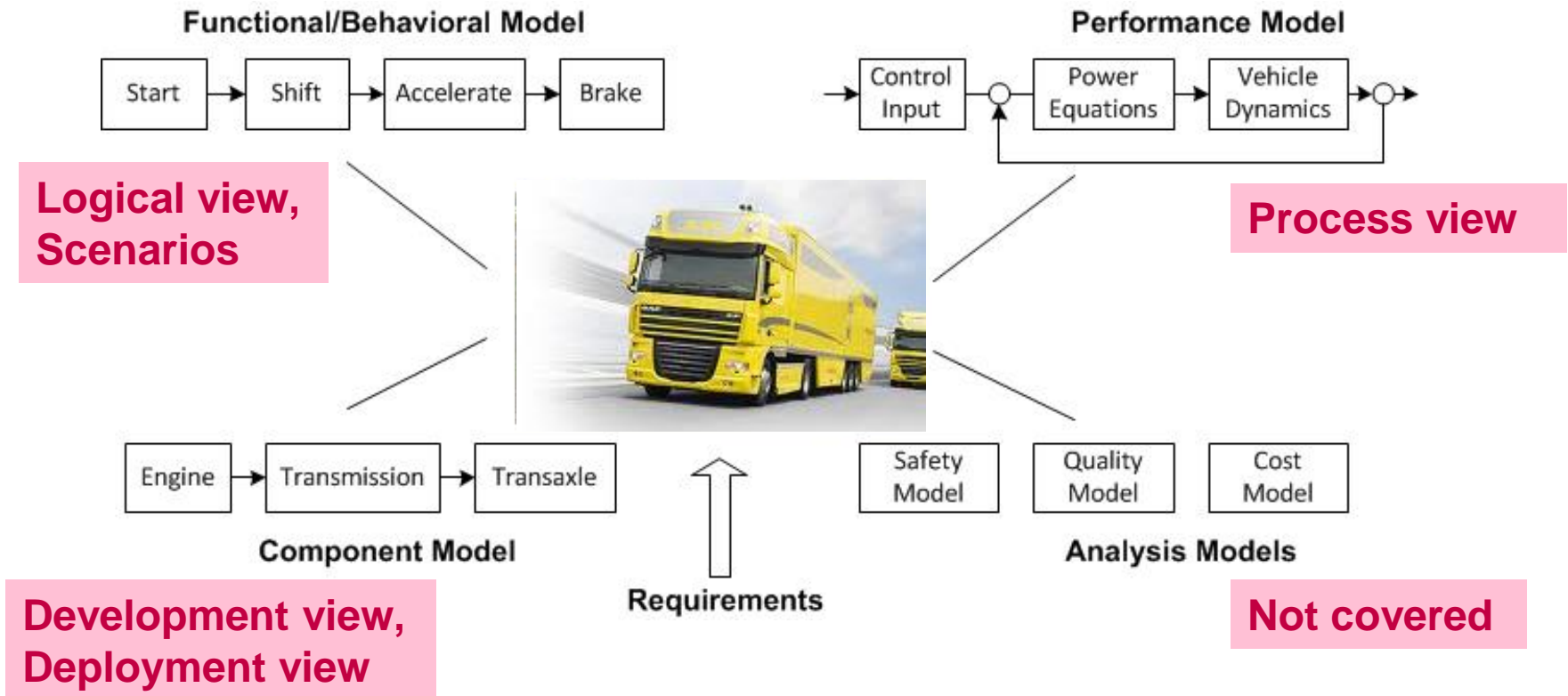

Another take on *viewpoints* (here called *model(s)*)

Can you map those models to Kruchten's 4+1?

Multiple choice question (13)

Rozanski and Woods have identified a concurrency viewpoint: describes the concurrency structure of the system and maps functional elements to concurrency units to clearly identify the parts of the system that can execute concurrently and how this is coordinated and controlled. This entails the creation of models that show the process and thread structures that the system will use and the interprocess communication mechanisms used to coordinate their operation.

Which one of the Kruchten's 4+1 views addresses this concern

- a) Process view
- b) Logical view
- c) Scenarios
- d) None of the above

Multiple choice question (13)

Rozanski and Woods have identified a concurrency viewpoint: describes the concurrency structure of the system and maps functional elements to concurrency units to clearly identify the parts of the system that can execute concurrently and how this is coordinated and controlled. This entails the creation of models that show the process and thread structures that the system will use and the interprocess communication mechanisms used to coordinate their operation.

Which one of the Kruchten's 4+1 views addresses this concern

- a) **Process view**
- b) Logical view
- c) Scenarios
- d) None of the above

Exam

- **April 15, 9:00 – 12:00**
- **Location: check OASE**

- **Part I. 20 multiple choice questions (4 options)**
 - 2, if Indicated = Correct
 - 1, if Indicated \subseteq Correct
 - 0, otherwise

- **Part II. Five modeling exercises (15 points each)**
 - Choose four
 - We'll grade the first four

Questions like the ones we have seen today

Exercises like the ones you have seen during the instruction sessions + today

Success on the final exam!

Alexander, Anton, Kees,
Sarmen, Ulyana, Yanja